

DataPhysics

Products for surface chemistry

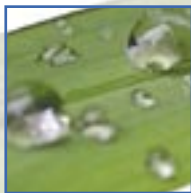
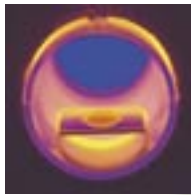
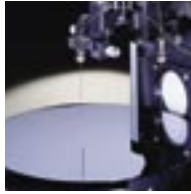

~~dataphysics~~

... Halle-Wittenberg
... of Brno/Czech Republic
... Co.KG/Germany • Beiersdorf AG/Germany
... Australia • Max-Planck-Institute for Polymer
... Chemie GmbH/Germany • TetraPak GmbH Surface Characterization
... er-Gesellschaft IZM/Germany • ATP Alltape Klebebandtechnik GmbH/Germany • Papierfabrik August Ko
... VenLine C.A./Venezuela • ABB Forschungszentrum/Germany • University of Rostock/Germany • SC
... H & Co./USA • ARCH Chemicals/Belgium • STS Schreibgerätetechnik GmbH & Co.KG/Germany • ICI/Belgium
... Th. Goldschmidt AG/Germany • O+R Inkt Chemie BV./Netherlands • Yamanouchi Europe BV./Netherlands • Aurion Anlagentechnik GmbH/Germany • En
... GmbH/Germany • Philips Electronics GmbH • Hoechst Tresaphan GmbH/Germany • Pan Asian Plastics Corp./Taiwan • Forschungsz
... t Britain • Max-Planck-Institut für Silikatforschung/Germany • BASF AG/Germany • University Bayreuth/Germany • Forschungsz
... -Gesellschaft (HSG)/Germany • Alcan Rorschach AG/Switzerland • Xerox/USA • Future Digital Scientific Corp./USA • Eberhard-Karls-Universität • Fraunhofer
... imec/Belgium Leuven • Papierfabrik Louisenhof GmbH/Germany • Hermsdorfer Institut für Technische Keramik/Germany • Redco/Belgium • V
... Ciba Spezialitätenchemie AG/Switzerland • Dr. O. K. Wack Chemie GmbH/Germany • OSRAM Opto Semiconductors GmbH & Co. OHG/Malaysia
... Germany • Audi AG/Germany • Micron Technology Inc./USA • Fraunhofer-Institut IST/Germany • Felix Böttcher GmbH/Germany • Wako-Che
... GmbH/Germany • Deutsche Forschungsgemeinschaft DFG for University Ulm/Germany • University of Melbourne/Australia • Fachhochschule Hamburg/Germany • Fraunhofer
... GmbH/Germany • Woehlik Kontaktlinsen GmbH/Germany • Benckiser Produktions GmbH/Germany • Procter & Gamble Italy/Italy • Tsinghua University/China • Automot
... /Japan • Schweizerische Munitonsunternehmung • Fresenius Medical Care Deutschland GmbH/Germany • Solutia Inc./USA • Valeo Auto-Electric/Germany
... Gesellschaft/Germany • Bergische Universität Wuppertal/Germany • Celestica Italia/Italy • Dompé SpA/Italy • Ajinomoto Corp./Japan • Advantage Scientific, Inc
... Gesellschaft DFG for University Stuttgart/Germany • Christian Albrechts-Universität Jülich GmbH/Germany • Poliklinik für Zahnerhaltung un
... /Germany • Lion Corporation/USA • Voestalpine Stahl Linz GmbH/Austria • Forschungszentrum Jülich GmbH/Germany • Poliklinik für Zahnerhaltung un
... /Germany • Mokpo National University/China • Fachhochschule Lippe/Germany • Schepens N.V./Belgium • University of Minho/Potugal • Freudenberg Forschungsdi
... /Germany • DFG for University Darmstadt/Germany • Agilent Technologies Inc./USA • University of Technology/Australia • Hahn-Meitner-Institut Berlin GmbH (H
... /Portugal • Qing Dao Qingjin Machine Co./China • Max-Planck-Institut für Mikrotechnik Mainz GmbH/Germany • Conexant Inc./US
... /Hungary • Royal Melbourne Institute of Technology/Australia • Europlasma/Belgium • University Erlangen-Nürnberg/Germany • Aesculap
... /Germany • Philips Enabling Technologies Group/Netherlands • Degussa-Hüls AG/Germany • Forschungsinstitut für
... /USA • Eötvös Loránd University of Budapest/Hungary • Fachhochschule Lippe/Germany • Hahn-Meitner-Institut Berlin GmbH (H
... /USA • ALCON Co./USA • Capitol Normal University/China • Degussa-Hüls AG/Germany • Conexant Inc./US
... /USA • Cognis Deutschland GmbH/Germany • General Electric India Technology Center Pvt. Ltd./India • National Tsing
... /USA • Meiji Agrochemicals/Japan • Bioslide/USA • Zhong
... /Austria • Inkjet Technologies/USA • Universität Würzburg-Schweinfurt/Germany • Soremar
... /USA • Procter & Gamble
... /Italy • Procter & Gamble

All rights reserved. No part of this work may be reproduced, distributed, or otherwise processed in the form of translations, reprints, photocopies, microfilms, or any other method, mechanical or electronic, without the prior written permission of the company DataPhysics. These restrictions do not apply to the exceptional cases specified under §§ 53, 54, 55 of the German copyright act UrhG.

The use of names, trade names, merchandise descriptions and such in this document does not justify the assumption that such names may simply be used by anyone; often we are concerned with legally protected registered trademarks even if they are not marked as such.

Text: Torsten Holz
Artwork and layout: Bild & Text Gestaltung GmbH, Stuttgart

Printed in Germany, April 2003
© Copyright 2002 by DataPhysics Instruments GmbH, Filderstadt

®DataPhysics is a registered trademark of DataPhysics Instruments GmbH
®Microsoft and ®Windows are registered trademarks of the Microsoft Corporation

About DataPhysics

A history of the company

The company DataPhysics Instruments GmbH was founded in 1997 in Filderstadt near Stuttgart, Germany, by specialists with many years of experience in surface chemistry. Since then our scientists and engineers have been developing in close cooperation with customers throughout the world, including science and research institutes, new measuring instruments and systems for investigating the processes of surface chemistry in laboratory and process applications. Our primary objective is to translate the power of innovation into the advancement of interfacial and measurement engineering and to develop the superior products for our demanding customers. As a result, we have created a corporate culture that motivates competent and creative staff in all departments to join forces for the best results in a common goal: perfection. If you want to know more about surface chemistry or the company DataPhysics, simply ask for our booklet "Surface Chemistry – An attractive science" or download the PDF file from our web site. In this booklet, the DataPhysics' team escorts you through the fascinating world of surface chemistry, with a wealth of background information on engineering, the measuring techniques, and references to key literature on a great number of applications.



Visit our web site at

www.dataphysics.de

to learn a great deal more about other important aspects of our company, e.g. your contacts in each of our divisions, road maps to our head office, the addresses of our representatives abroad, etc. Have any questions? Just give us a call.

We'll be there for you – guaranteed!

Table of contents

Our product range	Page
Optical contact angle measuring instruments	6
OCA 30 / OCAH 230 Automatic, video-based contact angle measuring instruments	8
OCA 20 / OCAH 200 / OCA 15 plus / OCAH 150 plus Video-based optical contact angle measuring instruments	10
OCA 10 / OCA 5 Manual optical contact angle measuring instruments	12
ACA 50 Fully automatic, video-based contact angle measuring instrument	14
Accessories for OCA and ACA A modular system for diverse combinations	16
Special accessories for OCA Special-purpose expansions to the modular system	18
PCA 100M Video-based portable contact angle measuring instrument	20
PCA 100R Robot-assisted contact angle measuring instrument for process control	22
Tensiometers	24
DCAT 21 / DCAT 11 Dynamic contact angle measuring instruments and tensiometers	26
SVT 20 Video-based spinning drop tensiometer	28
The applications center for surface chemistry Customized applications Database and internet information Seminars and workshops Hotline and services	30
Data sheets Specifications of OCA / ACA Specifications of PCA / DCAT / SVT	32

Our product range — Optical contact angle measuring devices

video-based measuring with method and precision

In most diverse engineering applications the ability of liquids to wet solids affects the quality of products and their manufacturing processes. Some important examples are the manufacture and application of paints and varnishes, the development and production of composites, adhesives and their solvents for engineering

processes on the submicroscopic level. State-of-the-art optics, precise mechanisms, fast electronic controllers, and high-resolution video measurement guarantee the user of these DataPhysics instruments the right view in any measuring situation. After all, our development engineers benefit from many years of practical experience in these measurement techniques. We would like you to

in collecting, assessing, and evaluating measured data. DataPhysics has specialised in precise and reliable methods for evaluating drop contours with statistical error analysis. So that you can start straight away our physicists and software development engineers have put all their experience and creativity into the development of software modules of the SCA series. The software includes a liquids and solids database with currently over 170 records for all surface energy analysis methods plus references to further reading.

Every extension available for our software from the SCA 20 (static and dynamic contact angle measurement) to the SCA 26 (oscillating drop) introduces a further set of functions – all matched to your measuring needs.

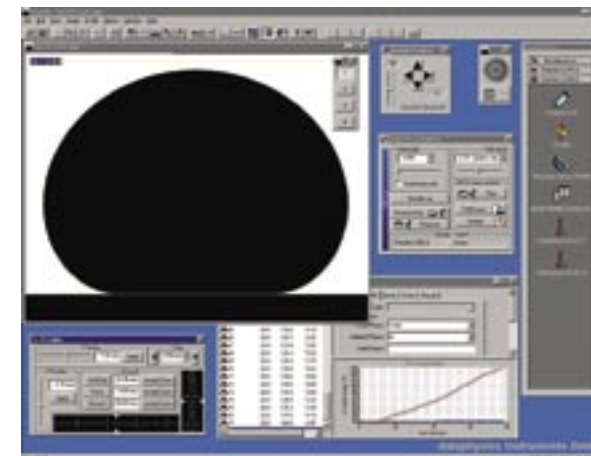

Contact angles measured on ultraphobic substrates



OCA 20 on the TBU 90E tilting base unit

materials, and the biocompatibility of medical implants. Application areas are subjects of precise investigations regarding static and dynamic contact angles as well as the surface and interfacial tensions between liquids and solids. Also the rapid advancements in nanotechnology and biotechnology are not the last to profit from the enhanced level of knowledge gained from wetting

benefit from this knowledge that is incorporated in our measurement equipment.

Software for efficient work

The optical contact angle measuring instruments from DataPhysics feature intuitive applications software with many graphical elements to assist you in specifying measurement procedures and

Accessories and customised modifications

The following presents the most important information on our laboratory and process contact angle measuring instruments together with their specifications. All OCA systems can be upgraded to the higher configurations in the series. Standard accessories and robot systems are available as a wide range of expansions for the ACA 50 also.

Whether for small or large samples, at high or low temperatures, or for the OCA or ACA modular systems, our accessories nearly always provide a solution suitable for the diverse needs of our users. And if they do not, just ask us for special-purpose variants of our instruments and system components. In most cases we can modify our components to meet your particular needs.

Optical standards for precise results

For its optical contact angle measuring instruments, DataPhysics provides several sets of optical standards (OCAS) on glass substrates with standard drop contours (pendant and sessile drop according to Young-Laplace or height/width) as well as liquid lamellae. They have been manufactured with the highest precision as per ISO 9001 in a controlled photolithographic process to serve as reliable references for the precision of measured data.



OCAS glass substrates with standard drop contours

Flexibility is standard at DataPhysics

OCA 30/OCAH 230

Video-based automatic contact angle measuring instruments

What you can measure with the OCA 30 and OCAH 230

The contact angle measuring systems OCA 30 and OCAH 230 are the all-round systems for exacting users who are looking for a high level of automatic comfort in the measurement of wetting properties. Easy to use and facilitating fast access to all control elements, the software package SCA 20 version 2 for Windows provides these instruments with the following functions:

- measurement of static and dynamic contact angles with max. four different liquids (or max. six with the special variant E-MD/6) (optional),
- easy repetition of measurements,
- automatic needle (test liquid) selection and controlled positioning,
- measurement of surface and interfacial tensions,
- determination of absorption properties on absorptive papers and non-wovens,
- calculation of surface free energies on solids and liquids as well as their contributions.

The automatic sequence of measurements conducted by the OCA 30 / OCAH 230 facilitates fast and highly reproducible results on both simple and complex sample structures at "the push of a button".

Components and accessories

- high performance 6x parfocal zoom lens with an integrated continuous fine focus, and adjustable observation and camera angles,
- video measuring system with high-resolution CCD camera and high-performance digitizing adapter (for max. 1280 x 1024 pixels),
- max. 50/60 images per second (OCA 30) or max. 360 images per second (OCAH 230),



OCA 30 with E-MD/4 electronic dosing system and keypad

- measuring stage software controlled motorized adjustable in y-z axis,
- E-MD electronic multiple dosing systems with max. four dosing needles (max. six with the special variant E-MD/6) and ES electronic syringe units (optional),
- electronic tilting base units (TBA 60E and TBU 90E), wafer tables up to 12" (300 mm) with the extended variant OCA 30L, and temperature control systems (optional),
- refill and rinse system with liquid pump cleaner RRS-LPC 3/1 (optional).

Windows software

The 32-bit software developed for Windows NT / 2000 / XP is available in various configurations for the following functions:

- control processes for the sample position in y-z direction, selection and positioning of needles (with the optional E-MD), electronic syringe units, tilting and wafer tables, tilting base units, and electric temperature control systems from -20 °C to 1700 °C,
- calculation of surface free energies on solids and their contributions with specified error limits,
- generation of wetting envelope diagrams and work of adhesion / contact angle diagrams derived from surface free energies,
- calculation of disperse and polar contributions of liquids according to various methods,
- conversion of recorded video sequences to AVI and MPEG formats,
- statistical evaluations and error analysis (SPC) with averaging, standard deviation, consistency checks within the specified limits, histograms, etc.
- access and management to a liquids and solids database with currently over 170 records for all surface energy analysis methods plus references to further reading.



Refill and rinse system with liquid pump cleaner RRS-LPC 3/1 for OCA

Wafer table on the OCA 30

Software menus and control elements

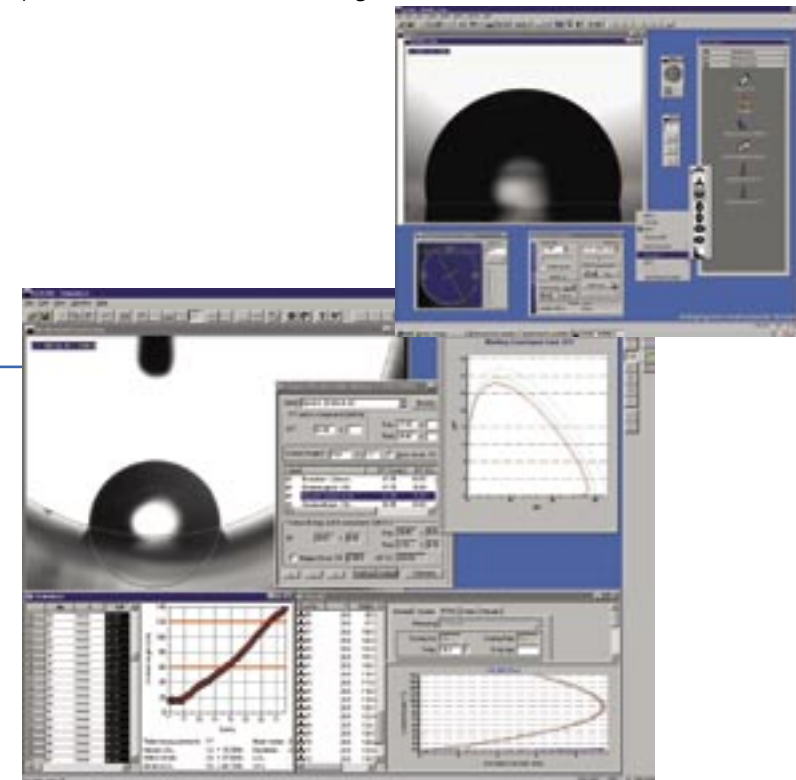

SCA 20 – measuring and evaluating wetting properties of solids

OCA 20/OCAH 200 OCA 15 plus/OCAH 150 plus

Video-based optical contact angle measuring instruments

What you can measure with the OCA 20 / OCAH 200 / OCA 15 plus / OCAH 150 plus

The contact angle video measuring systems OCA 20 and OCAH 200 are the standard systems for exacting users, whereby the OCAH 200 and OCAH 150 plus allow data transfers of up to 360 images per second. Easy to use and facilitating fast access to all control elements, the software package SCA 20 version 2 for Windows provides these instruments with the following functions:

- measurement of static and dynamic contact angles with

- max. four (max. six with the special variant E-MD/6) different liquids (optional),

- automatic needle selection and positioning,

- measurement of surface and interfacial tensions,

- determination of absorption properties on absorptive papers and non-wovens,

- calculation of surface free energies on solids and liquids as well as their contributions.

The contact angle measuring instruments OCA 20 / OCAH 200 / OCA 15 plus / OCAH 150 plus can determine the wetting properties, surface tensions, and

surface energies on the most diverse solids and liquids. Optical image processing also facilitates measurements with a high degree of reproducibility.

At the same time, the OCA 15 plus and the OCAH 150 plus are budget alternatives for users who can work with only one dosing system, e.g. to determine the surface tensions of higher-viscosity liquids such as printing inks and adhesives. In these cases, the OCA 15 plus and the OCAH 150 plus can be equipped with the SD-DM direct dosing system that can also easily work with disposable needles and syringes.

Components and accessories

- high performance 6x parfocal zoom lens with an integrated continuous fine focus, and adjustable observation and camera tilt angle,

- video measuring system with high-resolution CCD camera

- and high-performance digitizing adapter (for max. 1280 x 1024 pixels), max. 50/60 images per second (OCA 20 and OCA 15 plus) and max. 360 images per second (OCAH 200 and OCAH 150 plus),

- E-MD and MD electronic and manual multiple dosing systems with max. four dosing needles (max. six with the special variant E-MD/6) and ES electronic syringe units (optional),

- SD-DE single dosing direct unit attached to the E-MD for higher-viscosity samples (optional),

- electronic tilting base units (TBA 60E and TBU 90E), wafer tables from 2" (50 mm) to 12" (300 mm) with the extended variant OCA 20L, and all temperature control systems (optional),

- refill and rinse system with



OCA 15 plus with SD-DM dosing system

liquid pump cleaner RRS-LPC 3/1 (optional).

The range of control functions provided by the OCA 15 plus and OCAH 150 plus includes the following:

- SD-DM single direct dosing unit,
- HTFQ 1200 and HTFC 1500 high-temperature measuring systems and the TDU 450 temperature display unit.

Windows software

The 32-bit software developed for Windows NT / 2000 / XP is available in various configurations for the following functions:

- control processes for the selection and positioning of needles (with the optional E-MD), electronic syringe units, tilting and wafer table, tilting base units, and for the electric temperature control systems from -20 °C to 1700 °C,

- measurement of static and dynamic contact angles on plane, convex, and concave surfaces,

- determination of surface and interfacial tensions based on pendant and sessile drop contours and on the interaction between liquid

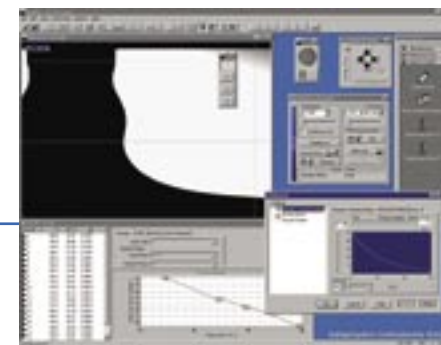

SCA 23 software for evaluating liquid lamellae

lamellae and test spheres or rods,

- calculation of surface free energies on solids and their contributions with specified error limits,

- generation of wetting envelope diagrams and work of adhesion / contact angle diagrams derived from surface free energies,

- calculation of disperse and polar contributions of liquids according to various methods,

- conversion of recorded video sequences to AVI and MPEG formats,

- statistical evaluations and error analysis (SPC) with averaging, standard deviation, consistency checks within the specified limits, histograms, etc.

- access and management to a liquids and solids database with currently over 170 records for all surface energy analysis methods plus references to further reading.



OCA 20 with E-MD/4 electronic dosing system

OCA 10/OCA 5

Manual optical contact angle measuring instruments

What you can measure with the OCA 10 and OCA 5

The OCA 10 and OCA 5 optical contact angle measuring systems are the manually operated entry-level systems for simple tasks.

Combined with the evaluation software SCA 10 version 2 for Windows, the OCA 10 provides the following functions:

- static and manually conducted dynamic measurement of contact angles with max. four different liquids,

with manual dosing systems only and without temperature display.

Both the OCA 10 and the OCA 5 can be upgraded for measuring the surface tensions of highly viscous liquids. Here, both instruments can be equipped with a SD-DM direct dosing system that also easily works with disposable needles and syringes.

Components and accessories

- high performance 6x parfocal zoom lens with an integrated continuous fine focus, and adjustable observation and camera angles,
- goniometric eyepiece providing precise read-offs against a 2x 0 – 180 ° scale,
- MD manual multiple dosing unit with adjustable horizontal and vertical needle positioning,



OCA 10 with MD multiple dosing unit

- calculation of surface free energies on solids as well as their contributions with the software SCA 10 (optional).

The OCA 5 is a budget alternative for users who work predominantly

- SD manual single dosing unit with adjustable horizontal and vertical needle positioning,

- SD-DM manual single dosing direct unit with adjustable vertical and horizontal needle positioning,

- TBA 60M manual tilting base assembly and wafer tables up to 12" (300 mm) with the extended variant OCA 10L (optional),

- TFC 100 thermal liquid temperature control unit from -10 to 110 °C with installed Pt 100 temperature sensors,

- max. four manual syringe units MS .

Windows software

The 32-bit software SCA 10 developed for Windows NT / 2000 / XP is available in various configurations for the following functions:

- calculation of surface free energies on solids and their contributions with the specified error limits,
- generation of wetting envelope diagrams and work of adhesion / contact angle diagrams derived from surface free energies,
- access and management to a liquids and solids database with

currently over 170 records for all surface energy analysis methods plus references to further reading.

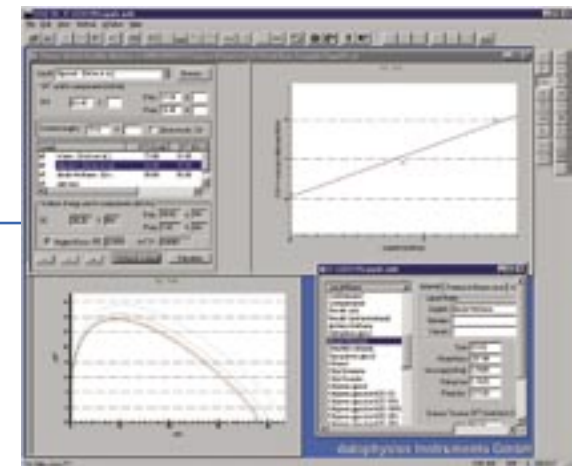

SCA software for analysing the surface free energy

Upgrades

The optical contact angle measuring instrument OCA 10 and the extended variant OCA 10L can be upgraded max. to the OCA 30(L) including the high-speed video option OCAH 230(L).

The OCA 5 can be expanded to the OCA 15 plus, which can control one ES/2 or ES/2-D electronic syringe unit with the SCA 20 software.



OCA 5 with SD single dosing system

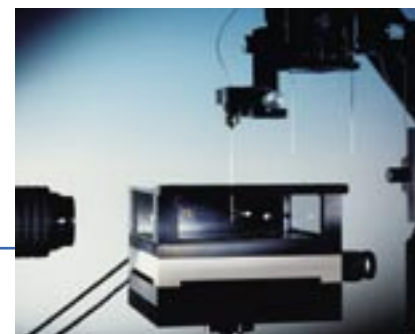

OCA with TFC 100 thermal liquid temperature control unit

ACA 50

Fully automatic, video-based contact angle measuring instrument

What you can measure with the ACA 50

The fully automatic contact angle measuring system ACA 50 is the optical instrument with the highest degree of automatic comfort for the measurement of wetting properties. The extensive controller software is designed for ease of use, coupled with fast access to all control elements.

The ACA 50 provides the following functions:

- measurement of static and dynamic contact angles with max. six different test liquids,



ACA 50 with wafer table and six electronic syringe units

- measurement of surface and interfacial tensions,
- automatic needle selection and positioning,

- determination of absorption properties on absorptive papers and non-wovens,

- easy repetition of measurements,

- automatic calculation of surface free energies on solids and liquids as well as their contributions with-out user intervention.

The automatic sequence of measurements and the optical image processing facilitate fast and highly reproducible measurements on both simple and complex sample structures at "the push of a button".

In addition, the ACA can be expanded with robots from the DataPhysics RCC series for the fully automatic loading and unloading of samples.

Components and accessories

- high performance lens with software controlled motorized 7x zoom, focus, aperture, and tilt,

- video measuring system with high-resolution CCD camera and high-performance digitizing adapter (for max. 1280 x 1024 pixels),

- AM-D electronic multiple dosing system with max. six dosing needles and ES-A electronic syringe units (optional),

- software controlled motorized x-y-z measuring stage,

- electronic tilting base unit (TBA 60E), wafer tables with up to 12" (300 mm), and temperature control systems (optional),

- refill and rinse system with liquid pump cleaner RRS-LPC 3/1 (optional).

Windows software

The 32-bit software developed for Windows NT / 2000 / XP is available in various configurations for the following functions:

- control processes for positioning the sample along the x, y, and z axis, for the selection and positioning of needles, for the optics, for the illumination, for the electronic syringe units, for the tilting and wafer tables, and for the electric temperature control systems from -20 °C to 400 °C,

- generation, management, and implementation of measuring procedures,

- measurement of static and dynamic contact angles on flat, convex, and concave surfaces,

- determination of surface and interfacial tensions based on pendant and sessile drop contours and on the interaction between liquid lamellae and test spheres or rods,

- calculation of surface free energies on solids and their contributions with specified error limits,

- generation of wetting envelope



ACA 50 with the RCC robot system automatically loading coated glass wafers for measuring

standard deviation, consistency checks within the specified limits, histograms, etc.

- access and management to a liquids and solids database with currently over 170 records for all surface energy analysis methods plus references to further reading.



ACA 50 with A-MD electronic dosing system and WT 200E wafer table

diagrams and work of adhesion / contact angle diagrams derived from surface free energies,

- calculation of disperse and polar contributions of liquids based on measured surface and interfacial tensions and on contact angles with error limits,

- conversion of recorded video sequences to AVI and MPEG formats,

- statistical evaluations and error analysis (SPC) with averaging,

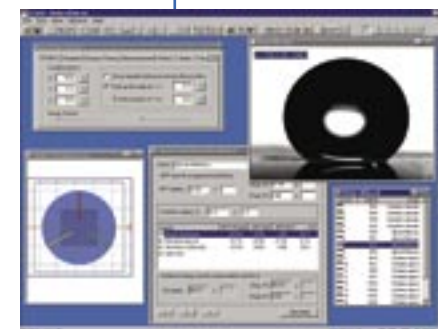

Software SCA 50 – dialog box for test parameters

Accessories for OCA and ACA

A construction kit for diverse combinations

The contact angle measuring instruments from the OCA and ACA series share a common feature – the combined OCA/ACA construction kit. This extensive range of accessories consists of various dosing systems, temperature control systems, wafer and tilting tables, and tilting base units.

Advanced dosing technology

The most important system components also include the electronic syringe units and multiple dosing units.

ODG 20 oscillating drop generator. Accordingly, liquid drops can be driven to controlled oscillations in a frequency range from 0.01 to 20 Hz.

In the basic version, the ACA 50 can take up to six optional dosing syringes to dispense predefined quantities of liquid through a multiple dosing system. The smallest volume of liquid to dispense with the E-MD and A-MD multiple dosing units ranges from 30 to 50 nL, depending on the liquid and the diameter of the dosing needle.

The easy automatic measurement of the contact angle hysteresis

(ARCA) works both with the software SCA 20 and the SCA 50.

Temperature control – getting it hot or cold

The user can choose from a wide range of temperature control systems that operate in conjunction with the OCA and ACA systems for the most diverse applications at temperatures from -20 °C to 1700 °C.

The following temperature control systems for the OCA 20 and higher can be controlled by software:

- TPC 150 (temperature control chamber with electric Peltier system for -20 to 150 °C),
- TEC 400 (temperature con-



ES electronic syringe units



SCA 20 software for defining ARCA

control chamber with twin electric resistance heater for ambient to 400 °C),

- NHD 400 (electrically heated needle and dosing system for polymer and hot melts up to 400 °C),
- high temperature furnace HTFQ 1200 and other customer specific systems (up to 1700 °C), can also be controlled with the OCA 15LHTplus.

can be used in combination with the optional Pt 100 temperature sensors.

Rolling drops

For the measurement of rolling angles of inclined surfaces DataPhysics provides manual or electronic tilting assemblies and tilting base units. The tilting base assemblies TBA 60M (manual) and TBA 60E (electronic) can be used with the contact angle measuring instruments of the



TPC 150 Peltier temperature control unit

The instruments from the OCA standard series work with up to four dosing systems, and the special variants up to six. From the OCA series of contact angle measuring instruments, the OCA 20 and higher can also operate the

In addition to the software interface, the temperature control systems can be operated manually as well.

The following temperature control units are also suitable for use with the ACA 50:

- TFC 100 thermal liquid temperature control unit from -10 to 110 °C with installed Pt 100 temperature sensors,
- TPC 150 (Peltier system) and TEC 400 (electric heating system with optional counterflow gas cooling).

All OCA (from OCA 15 plus with TDU 450) and ACA systems are equipped with two independent temperature measuring channels for the -60 to 450 °C range that

OCA and ACA series. The tilting base unit TBU 90E was designed for use with the OCA series (from OCA 20). The TBA 60E and the TBU 90E can be controlled by software.



E-MD electronic multiple dosing unit



TBA 60E electric tilting base assembly

Special accessories for OCA

Special-purpose expansions to the modular system

Oscillating drops

Measurements of surface elasticity at phase boundaries have been of interest to surface chemists for more than thirty years. Since the publication of the standard works by Lucassen and van den Tempel the number of scientific publications in this field have constantly grown, and interesting applications have been described in foam stability and the behaviour of biomolecules at phase boundaries. In this respect, DataPhysics has developed the ODG 20 oscillating

drop generator with a wide range of frequencies and amplitudes. Periodic variations in the drop volume, or alternatively in the drop shape with constant volume can be performed. Furthermore, the drop surface area can be kept constant and the drop volume is varied accordingly. The excitation frequencies ranges from 0.01 to approx. 20 Hz, depending on the density and viscosity of the fluid whereby the amplitude of the axis-symmetric oscillations varies from just a few micrometers to millimeters.

LIA-MD liquid injection system

The relaxation properties of drops on the addition of a second liquid constituent can be studied with the LIA-MD liquid injection system. In this case, a dose of a different surface-active or chemically reactive phase is added to an existing drop in a very short time. The primary drop must now return to the equilibrium on its interface. In the ensuing reaction time the surface and interfacial tensions can be measured and their behaviour investigated. Developments of synthetic eye and lung fluids for medical purposes have already profited from this idea, and more innovative applications are expected in the field of protein and surfactant engineering.

NHD 400 needle dosing system

When polymer melts, liquid metals including solders, or salts have to be dosed, the NHD 400 heated needle dosing system is just the right accessory. From a molten and gas-free reservoir in a TEC 400 or TPC 150 temperature control chamber, a small quantity of the sample is drawn into the

heated needle at temperatures up to 400 °C and redosed for measurement as a pendant or sessile drop. This method has the decisive advantage that homogeneous, gas bubble-free material is always produced and the disposable dosing needles including other system components do not have to be cleaned afterwards. Also extremely tenacious copolymers with viscosities in the kPas range, e.g. with elastomer constituents, can be dosed without difficulty with the NHD 400.

Direct dosing systems SD-D(M/E)

Viscous paints, varnishes, and latex dispersions are typical applications for the SD-DM and SD-DE direct dosing systems. Both of these direct single dosing systems can be used to dose either pendant or sessile liquid drops (on a substrate) through dispos-

able needles without the need for tubing. At the same time, both the liquid volume and the dosing rate can be precisely defined. This is where the two SD-D(E) dosing systems differ from the conventional manual direct dosing systems. The SD-DE finds application as an attachment on the E-MD electric multiple dosing system,

whereas the SD-DM can be mounted as a stand-alone system on the illumination housing of all OCA instruments.

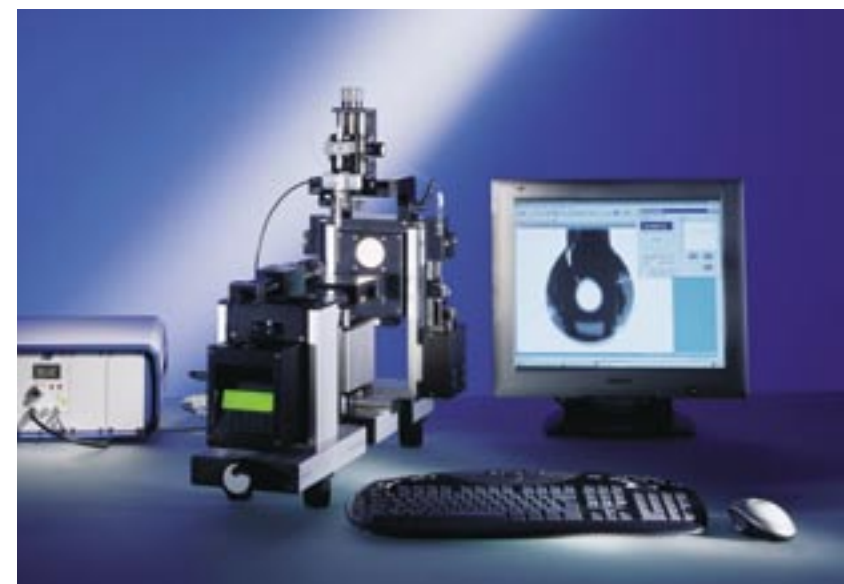

OCA 30 with the ODG 20 oscillating drop generator

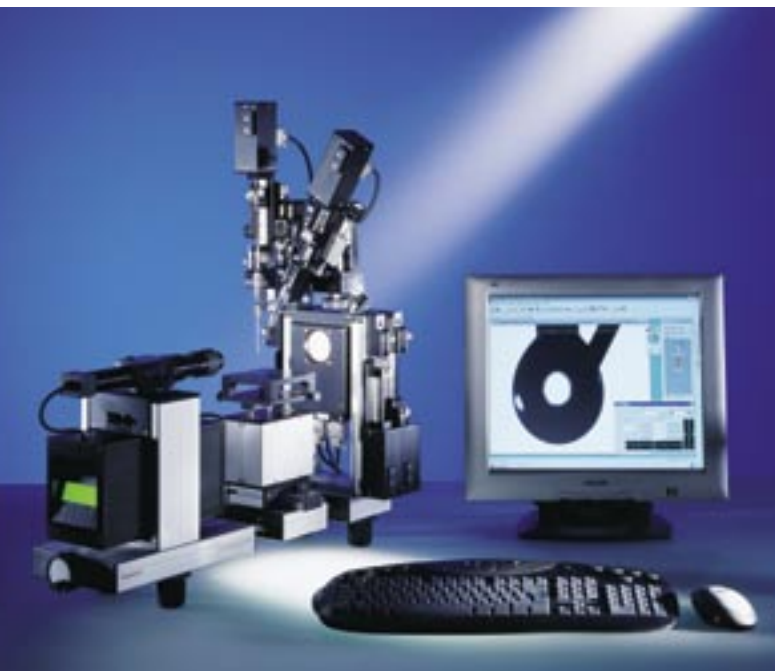

OCA 30 with the LIA-MD liquid injection system

drop generator for determining the complex interfacial dilatation modulus. This extension to the OCA instruments (from OCA 20) – based on a piezoelectric source – excites oscillating drops



NHD 400 with TEC 400



E-MD electric multiple dosing system with SD-DE

PCA 100M

Video-based portable contact angle measuring instrument

What you can measure with the PCA 100M

The video-based portable contact angle measuring instrument PCA 100M is the optical instrumentation system for measuring wetting properties on site during the production process.



Dosing and refill system for the PCA 100M/4

The controller software is designed for ease of use and fast access to all control elements and can be used on a notebook or laptop. Combined with the software SPCA 100 version 2 for Windows, the PCA 100M provides the following functions:

- measurement of static and dynamic contact angles with max. four different test liquids,
- easy repetition of measurements,
- automatic needle selection and controlled positioning,

- determination of absorption properties on absorptive products such as papers or the spreading behaviour on plastic films,

- calculation of surface free energies on solids as well as their contributions.

Whether for large or small areas, the PCA 100M is the handheld instrument for controlling the qualities of coatings, examining the surface energies of plasma-treated or corona-etched polymer films in the production process, or testing the qualities of cleaned or adhesion-promoted glass surfaces prior to the next processing stage.

Components and accessories

- high-performance telecentric lens with integrated aperture and adjustable observation angle,

- video-based measuring system with high-resolution CCD camera and high-performance digitizing adapter (for max. 752 x 582 pixels),

- electronic illumination with intensity controller for homogeneous backlighting,

- installed multiple dosing systems, optionally with two or four dosing needles (PCA 100M/2 or PCA 100M/4),

- integrated automatic refill system with flushing and cleaning functions for dosing up to 5000 drops per filling, and per liquid receptacle,

- optional combination with the PCA-MS measuring stand for laboratory table top applications.

Windows software

The 32-bit software developed for Windows NT / 2000 / XP is available in various configurations for the following functions:

- control processes for the selection and positioning of needles in horizontal and vertical direction and for the electronic syringe units with automatic refill function,

- generation, management, and implementation of measuring procedures for fully automatic measuring procedures,

- measurement of static and dynamic contact angles on flat, convex, and slightly concave surfaces,

- calculation of surface free energies on solids and their contributions,

- generation of wetting envelope diagrams and work of adhesion / contact angle diagrams derived



PCA 100M/4 on a glass substrate

- access and management to a liquids and solids database with currently over 170 records for all surface energy analysis methods plus references to further reading.



PCA 100M/4 with PCA-MS measuring stand

- from surface free energies,
- conversion of recorded video sequences to AVI and MPEG formats,

- statistical evaluations and error analysis (SPC) with averaging, standard deviation, consistency checks within the specified limits, histograms, etc.

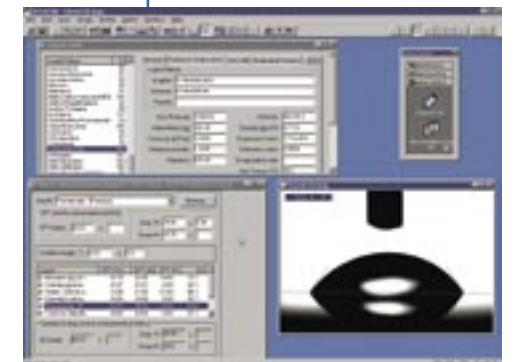

SPCA 100 software for measuring contact angles

PCA 100R

Robot-assisted contact angle measuring instrument for process control

What you can measure with the PCA 100R

In conjunction with the single- and multi-axis robots of the RCC series, the PCA 100R contact angle measuring instrument is a specialized system for measuring wetting properties on substrates of very large surface areas on site during the production process. Combined with the software packages SPCA 100 and SRC version 2 for Windows, the PCA 100R provides the following functions:

- fully automatic measurement of static and dynamic contact angles with max. four different test liquids (optional),
- automatic measuring head traverse, automatic needle selection, controlled needle positioning,

- graphical mapping of the contact angle, the drop base diameter, and other derived quantities,
- determination of the spreading behaviour on glass or ceramic substrates,
- calculation of surface free energies on solids as well as their contributions.

Components and accessories

- high-performance telecentric lens with integrated aperture and adjustable observation angle, as well as intensity controller for the backlighting,
- video-based measuring system with high-resolution CCD camera and high-performance digitizing adapter (for max. 752 x 582 pixels),
- installed electronic multiple dosing systems, optionally with two or four dosing needles,
- integrated automatic refill system with flushing and cleaning functions for dosing up to 5000 drops per filling, and per liquid receptacle,
- Combination with the following robots are possible: RCC-Z (z-axis system), RCC-XY (x/y-axis system up to 1600 mm) with fully or semi-automatic measuring

modes or with MT FPD easy-travel, manual sample tables up to 600 x 600 mm for positioning the measuring head and a one-button controller for initiating automatic procedures of contact angle measurements.

Windows software

The 32-bit robot-controller software SPCA 100 and SRC developed for Windows NT / 2000 / XP is available in various configurations for the following functions:

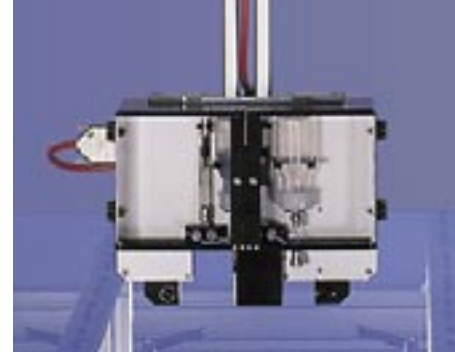

Mapping on a glass substrate with the PCA 100R/2

- control processes for the selection and positioning of needles in horizontal and vertical direction and for the electronic syringe units with automatic refill function,
- generation, management, and implementation of measuring procedures,
- measurement of static and dynamic contact angles on flat, convex, and slightly concave surfaces,
- calculation of surface free energies on solids and their contributions,
- generation of wetting envelope diagrams and work of adhesion / contact angle diagrams derived from surface free energies,
- conversion of recorded video sequences to AVI and MPEG formats,

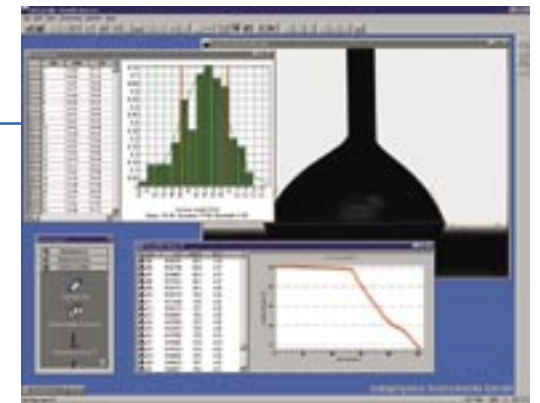

SPCA 100 software for measuring contact angles

- statistical evaluations and error analysis (SPC) with averaging, standard deviation, consistency checks within the specified limits, histograms, etc.
- access and management to a liquids and solids database with currently over 170 records for all surface energy analysis methods plus references to further reading.



PCA 100R/2 with RCC-Z 230 for 24" TFT LCD substrates



PCA 100R/2 with RCC-XY 1600 and RCC-Z 230 for 60" TFT LCD substrates

Tensiometers

Advanced instrumentation engineered for classical and new measuring techniques

The wetting properties of common solids can be measured with electronic tensiometers which have evolved to dynamic contact angle meters. The ease of use in providing highly reproducible results with these instruments has been achieved by extensive application of internal and external computer control. In addition, instruments such as the DataPhysics DCAT 21 or DCAT 11 provide a very high level of automation in the determination of wetting properties exhibited by powders, fibers, and fabrics as

DataPhysics. In a compact design, the SVT 20 is intended to supersede the traditionally manual operation of these tensiometer systems. With the additional feature of video contour recognition and evaluation technology, an important contribution can now be made to research in raw materials for emulsions, encapsulated drops, and tertiary oil recovery to the advantage of product quality and the preservation of the environment.

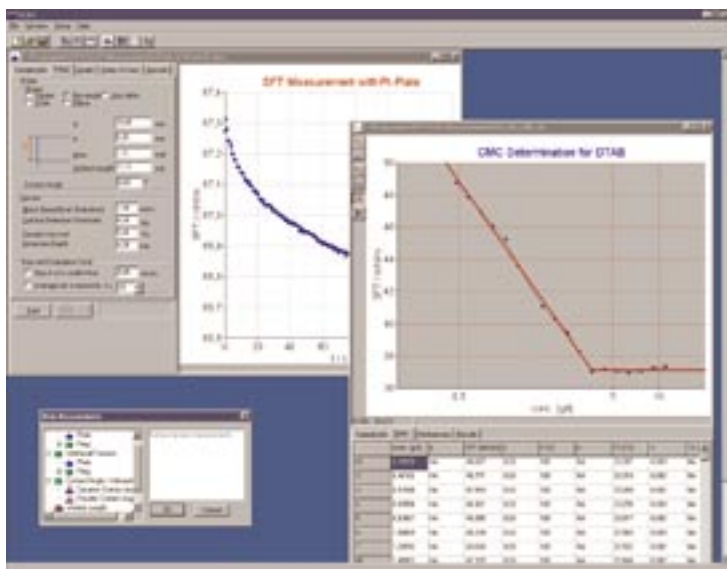

SCAT 32 software module for measuring surfactant properties (CMC)

well as the thermodynamic properties of surfactant solutions. One special instrument for measuring high to extremely low interfacial tensions is the spinning drop video tensiometer SVT 20. It is featuring the optical technology of the contact angle video-based measuring instruments from

Software for efficient work
The DCAT and SVT tensiometer systems are delivered with an intuitive PC software with many graphical elements to assist you in specifying both simple and complex measurement procedures and in collecting, assessing, and evaluating measured data.



Selection of measuring bodies and accessories for the DCAT 21 and DCAT11

Specifically the SCA 25/SVT software package for the SVT 20 spinning drop video tensiometer has profited from the wealth of precise and reliable methods to evaluating drop contours, e.g. the Young-Laplace method with statistical error analysis, which is also used for the optical contact angle measuring instruments of DataPhysics.

Utilize these gains in technology to your advantage.

Accessories and customized modifications

The tensiometers from DataPhysics can be modified with standard accessories to a wide range of measuring situations and sample geometries. The accessories for the DCAT modular system always provide a solution suitable for the diverse needs of our users, whether for films, sheets, fibers, powders, or magnetic and fabric

References for national and international standards

The dynamic contact angle measuring devices and tensiometers DCAT 21 and DCAT 11 are based on the latest balance technologies developed by the company Sartorius AG.

The monolith balance systems used by our instruments operate on the principle of electrodynamic compensation to combine the maximum precision with the greatest possible stability.

Both the DCAT 21 and the DCAT 11 are fitted with 100 g reference masses of class E2 (± 0.15 mg) as specified under R111 of the OIML (International Organization of Legal Metrology). This ensures that all tensiometer readings comply with national and international standards.

materials. And if they do not, just ask us for special-purpose variants of our instruments and accessories. In most cases we can modify our components to your particular needs.

As always, including Tensiometers, flexibility is standard.

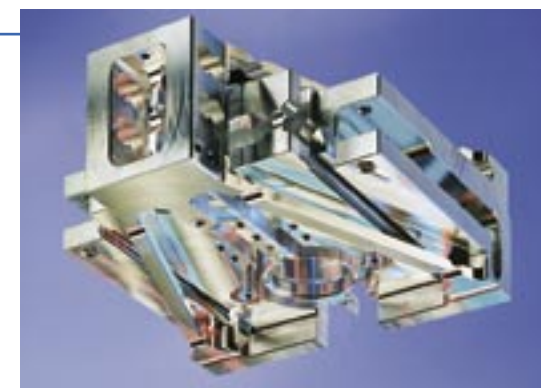

Monolith precision balance module

DCAT 21/DCAT 11

Dynamic contact angle measuring devices and tensiometers

What you can measure with the DCAT

The dynamic contact angle measuring devices and tensiometers DCAT 21 and DCAT 11 are the all-round systems for exacting users. The controller software designed for ease of use and fast access to all control elements and, combined with the software SCAT version 2.2 and higher for Windows, provides the following functions:

- measurement of contact angles

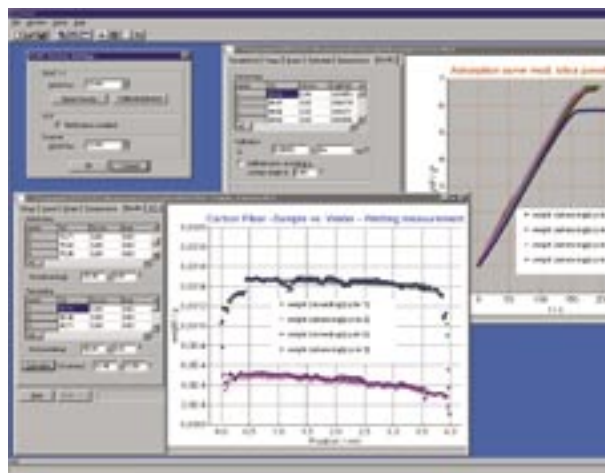

SCAT – measuring powders and thin single fibers

on powders, fibers, and fiber bundles and the adsorptive behaviour of liquids on wettable materials,

- measurement of dynamic contact angles (advancing and receding angles) on any prismatic and cylindrical sample geometries,
- measurement of static surface and interfacial tensions on liquids,

- determination of critical micelle concentrations (CMCs) on surfactant solutions including reverse CMCs,

- determination of liquid densities and the wetted length or diameter of solid samples,

- calculation of surface free energies on compact solids, fibers, and powders.

The optional dosing system LDU for the DCAT instruments also facilitates complex tasks such as combined dosing and redosing within a measuring cycle, forward and reverse CMCs, and mixtures of surfactant solutions in the determination of synergistic effects.

The DCAT 21 differs from the DCAT 11 in a higher travel resolution of 0.1 μm for the sample table, a higher travel speed, the automatic software-controlled coupling lock for the balance, and the greater maximum sample size for solids in sheet or rod form.



Components and accessories

- high-precision electrodynamic compensation weighing system with automatic calibration and a maximum data rate of 50 measured values per second,

- software-controlled, motor-driven, variable speed height adjustment for the sample receptacles,

- integrated measurement and control electronics with connections to two Pt 100 temperature sensors (internal and external),

- circulating thermal liquid temperature control up to 130 °C (optional); also available in a non-magnetic version with a removable microelectronic stirrer system,

- electrical temperature control unit TEC 250/DCAT for ambient to 250 °C (optional).

- illuminated sample chamber with inert gas or vapor inlet,

- LDU automatic dosing and refill system (optional),

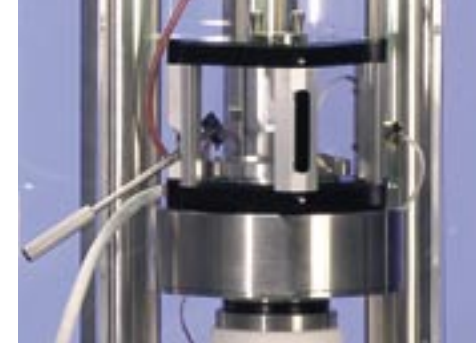

Electrical temperature control unit
TEC 250/DCAT

Windows software

The 32-bit software developed for Windows NT / 2000 / XP is available in various configurations for the following functions:

- measurement and evaluation of contact angles on the most diverse solid samples, including powders, fibers, and fiber bundles,

- measurement and evaluation of static, time-, and temperature-dependent surface and interfacial tensions of liquids,

- determination of critical micelle concentrations (CMCs) of surfactants, calculation of surface excesses, adsorption free energies according to Gibbs, occupied surface areas per molecule, and synergistic effects in surfactant mixtures,

- calculation of surface free energies and their contributions of solids and liquids,



LDU 2/2 dosing system for measuring CMCs with redosed surfactant solution

- determination of wetted lengths of solids,

- ring test for determining surface elasticities,

- generation of wetting envelope diagrams and work of adhesion / contact angle diagrams derived from surface free energies,

- determination of liquid densities and measurement of sedimentation rates in liquids and penetration rates by special sample geometries in viscous and plastic materials,

- access to the liquids and solids database.

DCAT 21 with FO 11
special sample holder for films

SVT 20

Spinning drop video tensiometer

What you can measure with the SVT 20

The spinning drop video tensiometer SVT 20 is a special-purpose optical instrument for measuring small to extremely low interfacial tensions. The controller software is designed for ease of use and fast access to all control elements.

Combined with the software packages SCA 20/SVT and SCA 25/SVT version 2 for Windows, the SVT 20 provides the following functions:

- measurement of static, time-, and temperature-dependent interfacial tensions between two not completely miscible liquids,
- automatic movement of the electronically controlled tilting base for positioning the spinning drops along the optical axis of the instrument,
- measurement of 2D and 3D extensional relaxation of viscoelastic liquids and liquid drops encapsulated or enclosed in membranes at varying speeds of rotation,
- determination of yield stresses on liquid-crystalline and pasty substances,
- calculation of disperse and polar contributions of liquids based on measured surface and interfacial tensions with error limits.



SVT 20 capillary with spinning drops

Components and accessories

- high-performance 6x power zoom lens with an integrated continuous fine focus and adjustable observation angle,
- video-based measuring system with high-resolution CCD camera and high-performance digitizing adapter (for max. 768 x 576 pixels),
- precision capillary system with electronically commutated DC drive for various capillary diameters,
- electronic tilting base for the capillary block, software-controlled motor-driven position and tilt adjustments,
- software-controlled speed of rotation and liquid flow rate,

- adjustable LED stroboscopic and steady illumination with triggered video system,
- integrated graphics display with touch panel functions,
- standard measuring capillaries with inner diameters of 8.0 or 2.45 mm of borosilicate glass or (optionally) quartz glass for UV polymerisation of drops,
- calibrating graduations for correcting optical distortions caused by the glass capillaries (cylindrical lens effects),
- LDU/SVT automatic dosing and refill system (optional).

Windows software

The 32-bit software developed for Windows NT / 2000 / XP is available in various configurations for the following functions:

- time-dependent control of the rotational speed, the inclination of the tilting base with the measuring cell, the flow rate of

- determination of dilatational interfacial elasticity, yield points, and other rheological parameters of viscoelastic and viscoplastic materials,

- calculation of dispersive and polar contributions of liquids based on measured surface and interfacial tensions with error limits,

- automatic compensation of temperature dependent changes of densities and refractive indices in the light and ambient phase,

- conversion of recorded video sequences to AVI and MPEG formats,

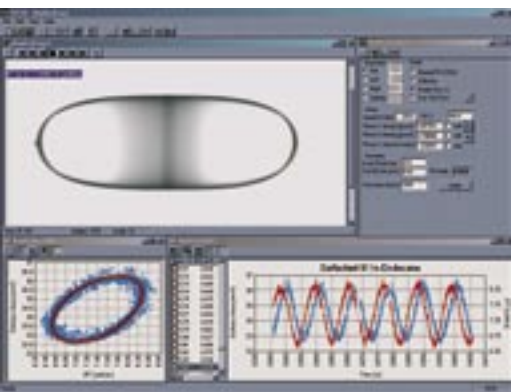

SCA 25/SVT – measurement of interfacial dilatational elasticity



Spinning drop tensiometer SVT 20 with automatic dosing and refill system LDU / SVT

- liquid through the capillary, and the camera position for observing the drops,

- recording and evaluation of video sequences for analysing fast relaxational oscillations and elongations of drops,

- calculation of interfacial tensions based on spinning drop contours according to various methods including the Young-Laplace method,

- statistical evaluations and error analysis (SPC) with averaging, standard deviation, histograms, etc.

- access to the liquids and solids database.

The applications center for surface chemistry

Customized applications

At the surface chemistry application center run by DataPhysics, specialists in this field utilize state-of-the-art technology to investigate problems our customers encounter and to find joint solutions. With access to estab-



DataPhysics application laboratory

lished technologies for a majority of problems, our specialists not only perform the standard tasks of investigations. This comprises wetting and adhesive properties of paints and varnishes, surfactant and polymer solutions, powders and fibers, and non-wovens. Also the elaboration of detailed measuring and testing instructions, development of analytical methods, and new measuring techniques. Furthermore, solid and molten polymers, metals and adhesives, cosmetic and pharmaceutical products, engineering surfaces, coatings, electronic

components, and microstructures can be analyzed.

The results of our investigations can be presented in the form of test reports not only with a full description of the methodology, but also with graphical summaries and detailed discussions of the results. These can also include specific suggestions towards optimizing the product or process.

Where other experts find interfaces remain a phenomenon, we help to understand them.

Database and internet information

DataPhysics can provide you with the information relevant to your application from an extensive collection of electronic publications on surface chemistry. Application reports and database information round off this offer. For many applications there are important material parameters available that can be used, for example, to determine surface energies over wide temperature ranges. At the DataPhysics web site you are also provided with an updated overview of relevant references, a glossary, and a selection of links. Here you can also find an overview of the most important European and international standards on investigations into surface chemistry and a selection of tips and tricks.

Seminars and workshops

Twice a year DataPhysics hosts workshops on modern measuring techniques in surface chemistry. In addition, we shall also be pleased to organize application-oriented seminars on your premises on request. This gives a larger group of colleagues an opportunity to become acquainted with the theory and practice of instrumentation engineering and measuring techniques. Moreover, special instrument

User training



training on site or in our application laboratory paves the way towards an intensive exchange of experience and assistance in the translation of practice-relevant problems into suitable application programs.

We provide you with maximum support prior and after sales and installation.

Hotline and services

If you need help fast with issues concerning the configuration of instrumentation, software, or computers, please call the DataPhysics hotline at +49 (0)711 770556-45 during office hours from 9:00 am to 5:00 pm CET.

Competent staff will be pleased to assist you with any questions you have. Service and repair contracts extend the warranty period and ensure the unchanging quality of the measuring instruments and devices over many years of opera-

tion. Also the timely supply of accessories and incidentals is essential for a long and reliable life of the instruments. Accessories and incidentals are in stock and will be delivered at short notice and at reasonable prices.

In the areas of service and support we go beyond the limits.



System service

Technical data

	OCA 30/OCA 30L/OCAH 230/OCAH 230L	OCA 20/OCAH 200/OCA 15 plus/OCAH 150 plus and L-variants	OCA 10/OCA 5	ACA 50
Max. sample dimensions (L x W x H):	• 220 x ∞ x 70 mm, max. 8" wafer on WT 200M/E with OCA 30/OCAH 230 • 330 x ∞ x 60 mm, max. 12" wafer on WT 300M/E with OCA 30L/OCAH 230L	• 220 x ∞ x 70 mm, max. 8" wafer on WT 200M/E with OCA 20/15+/OCAH 200/150+ • 330 x ∞ x 60 mm, max. 12" wafer on WT 300M/E with OCA 20L/OCA 15 L+/OCAH 200L	• 220 x ∞ x 70 mm, 8" wafer on WT 200M with OCA 10/OCA 5 • 330 x ∞ x 60 mm, 12" wafer on WT 300M with OCA 10L	• 320 x ∞ x 70 mm, max. 12" wafer on WT 300M/E with auxiliary lens • active measuring surface: 150 x 150 mm, with swivel diameter 300 mm
Sample table dimensions:	• 100 x 100 mm OCA 30/OCAH 230 • 160 x 160 mm OCA 30L/OCAH 230L	• 100 x 100 mm OCA 20/15+/OCAH 200/150+ • 160 x 160 mm OCA 20L/15L+/OCAH 200L	• 100 x 100 mm OCA 10/OCA5 • 160 x 160 mm OCA 10L	• 100 x 100 mm
Traversing range of x-y-z sample table:	• 100 x 100 x 50 mm OCA 30/OCAH 230 • 220 x 155 x 50 mm OCA 30L/OCAH 230L	• 100 x 100 x 42 mm OCA 20/15+/OCAH 200/150+ • 220 x 155 x 42 mm OCA 20L/15L+/OCAH 200L	• 100 x 100 x 42 mm OCA 10/OCA5	• 150 x 150 x 40 mm
Measuring range for contact angles:	• 0...180 °; ± 0.1 ° measuring precision of video system		• 2x 0...180°; ±0.1° with measuring lens • up to ± 0.1° reading precision	• 0...180°; ±0.1° measuring precision of video system
Measuring range for surface and interfacial tensions:	• 1·10 ⁻² ... 2·10 ³ mN/m resolution: min. ± 0.05 mN/m		—	• 1·10 ⁻² ...2·10 ³ mN/m resolution: min. ± 0.05 mN/m
Positioning accuracy:	• ± 0.01 mm in the sample plane • ± 0.005 mm perpendicular to the sample plane	—	—	• ± 0.01 mm in the sample plane • ± 0.005 mm perpendicular to the sample plane
Max. sample weight:	3.0 kg	—	—	• 3.0 kg
Optics:	• 6-fold zoom lens (0.7 - 4.5 magnification) with integrated continuous fine focus (± 6 mm) • CCD camera with a resolution of max. 1600 x 1240 pixels (768 x 576 pixels standard) • FOV 1.75 x 1.4–11.7 x 9 mm, image distortion < 0.05%	—	• 6-fold zoom lens (0.7 - 4.5 magnification) with integrated continuous fine focus (± 6 mm) • goniometer eyepiece with 3.8–25 mm diameter FOV	• high performance lens with software controlled motorized 7 fold with zoom (0.7–5.25 magnification), focus (±5 mm), aperture, and tilt (± 5 °), • CCD camera with a resolution of max. 1600 x 1240 pixels (768 x 576 pixels standard), • FOV 1.2 x 0.9–8.5 x 6.4 mm, image distortion < 0.05%
Video system:	• high-performance image processing system with 132 MB/s data transfer rate (compatible with Euronorm CClR and US standard RS-170), 50 (optionally 60) images per second with OCA 20/15+ • variable digitizing rate with max. 360 images per second for OCAH 200 / 150+ / 230 (2000/4000 images per second with OCAH 2000 / 2030 planned)		—	• high-performance image processing system with 132 MB/s data transfer rate (compatible with Euronorm CClR and US standard RS-170), • variable digitizing rate 50 (optionally 60) images per second
Measuring techniques:	• Sessile and captive drop method, tilting table/base method • pendant and oscillating drop method, lamella method on test spheres and rods		• Sessile and captive drop Method • Tilting table method	• Sessile and captive drop method, tilting table method • pendant and oscillating drop method, lamella method on test spheres and rods
Software:	<ul style="list-style-type: none"> • SCA 20: video measurement of static and dynamic contact angles according to the sessile and captive drop as well as tilting table / base methods, measurement of drop and lamella contours, manipulation of max. 4 (6) ES electric dosing modules and other system components (E-MD/4(6), WT x00E/TBA 60E/TBU 90E, LDU) and of temperature control systems (TPC 150, TEC 400, NHD 400, HTFQ 1200, HTFC 1500) • SCA 21: calculation of surface free energies on solids and their contributions with error limits based on measured contact angles with any number of test liquids, evaluation according to Fowkes (geometric mean), Wu (harmonic mean), extended Fowkes (including H bonds), Zisman (critical surface tension), Owens-Wendt (disperse and polar), van Oss and Good (acid-base theory), Schultz I + II (two-liquid method), Neumann's Equation of State (EOS), calculation of disperse and polar contributions of liquids based on measured surface and interfacial tensions as well as contact angles with error limits, calculation of wetting envelopes and other diagrams • SCA 22: calculation of surface and interfacial tensions based on pendant drop contours and rising bubbles • SCA 23: calculation of surface tensions of liquids based on liquid lamellae on test spheres and rods • SCA 26: calculation of complex interfacial dilatation moduli based on oscillating drop contours (with OCA 30 / 230 / 20 / 200 / 2000 and oscillating drop generator ODG 20 only) 		<ul style="list-style-type: none"> • SCA 10: calculation of surface free energies on solids and their contributions with error limits based on measured contact angles with any number of test liquids, evaluation according to Fowkes (geometric mean), Wu (harmonic mean), extended Fowkes (including H bonds), Zisman (critical surface tension), Owens-Wendt (disperse and polar), van Oss and Good (acid-base theory), Schultz I + II (two-liquid method), Neumann's Equation of State (EOS), calculation of disperse and polar contributions of liquids based on measured surface and interfacial tensions as well as contact angles with error limits, calculation of wetting envelopes and other diagrams 	<ul style="list-style-type: none"> • SCA 50: video measurement of static and dynamic contact angles according to the sessile and captive drop as well as tilting table / base methods, measurement of drop and lamella contours, manipulation of max. 6 ES-A electric dosing modules and other system components (WT x00E / TBA 60E / LDU) and of temperature control systems (TFC 100, TPC 150, TEC 400) • SCA 51: calculation of surface free energies on solids and their contributions with error limits based on measured contact angles with any number of test liquids, evaluation according to Fowkes (geometric mean), Wu (harmonic mean), extended Fowkes (including H bonds), Zisman (critical surface tension), Owens-Wendt (disperse and polar), van Oss and Good (acid-base theory), Schultz I + II (two-liquid method), Neumann's Equation of State (EOS), calculation of disperse and polar contributions of liquids based on measured surface and interfacial tensions as well as contact angles with error limits, calculation of wetting envelopes and other diagrams • SCA 52: calculation of surface and interfacial tensions based on pendant drop contours and rising bubbles • SCA 53: calculation of surface tensions of liquids based on liquid lamellae on test spheres and rods
Temperature measurement and range:	• integrated temperature measurement and digital display 2 x Pt 100 inputs for -60 – 450 °C For OCA 15+/150+ as option		Pt 100 (as option), 0.1 K resolution, precision 1/3, DIN IEC 751 (±0.03%), Class B For OCA 5 as option	
Dimensions (L x W x H):	• OCA 30 / OCAH 230 / OCA 10 / OCA 5 OCA 20 / OCA 200 / OCA 15 + / OCAH 150+ • OCA 30L / OCAH 230L / OCA 10L OCA20L/OCAH 200L/OCA 15L+	590 x 220 x 550 mm 700 x 280 x 550 mm	• OCA 5 / 10 590 x 220 x 550 mm • OCA 10L 700 x 280 x 550 mm	• 830 x 330 x 450 mm
Weight:	• OCA 30 / OCAH 230 / OCA 20 / OCA 200L • OCA 30L / OCAH 230L • OCA 20 / OCAH 200 / OCA 15L+ • OCA 15+ / OCAH 150+	20 kg 21 kg 18 kg 16 kg	• OCA 5 16 kg • OCA 10 18 kg • OCA 10L 21 kg	• 35 kg
Power supply:	• 100...240Vac; 50...60Hz; 80 W		• 100...240Vac; 50...60Hz; 55 W	• 100...240Vac; 50...60Hz; 100 W

Technical data OCA/ACA

Technical data

	PCA 100M	PCA 100R and RCC
Max. sample dimensions (L x W x H):	• unrestricted, min. convex diameter of sample approx. 50 cm, min. concave diameter of sample approx. 100 cm	• 400 x 400 to 1600 x 1600 mm sample size standardized, bigger sample sizes on request, min. convex curve diameter of the sample approx. 100 cm, min. concave curve diameter of the sample approx. 200 cm
Dimensions of PCA-MS sample table:	• 100 x 100 mm, special sample tables and receivers, e.g. for printing rollers, on request	—
Measuring range for contact angles:	• 0...180 °; ±0.3 ° measuring precision of video system	
Max. sample weight:	• 3.0 kg on PCA-MS sample table	• approx. 30 kg on sample table
Optics:	• high-performance telecentric lens with integrated aperture and adjustable observation angle, • CCD camera with a resolution of max. 752 x 582 pixels • FOV 6.4 x 4.8 mm, image distortion < 0.4%	
Video system:	• high-performance image processing system with 132 MB/s data transfer rate (compatible with Euronorm CCR and US standard RS-170), • variable digitizing rate 50 frames per second	
Measuring techniques:	• sessile drop method – static and dynamic contact angle measurement	
Software:		<ul style="list-style-type: none"> • SRC: programmed control of all RCC components for defining fully automatic, semi-automatic, and direct command measurement procedures, definition of measuring grids and dosing sequences, visualisation of measuring results in colour-coded 2D presentations (mapping), database of samples and measuring results, interface to other robot systems (SECS II) • SPCA 100: video measurement of static and dynamic contact angles according to the sessile drop method, manipulation of max. 4 electric dosing modules with automatic refill function, definition of measuring procedures • SPCA 101: calculation of surface free energies on solids and their contributions with error limits based on contact angles measured with any number of test liquids, evaluation according to Fowkes (geometric mean), Wu (harmonic mean), extended Fowkes (including H bonds), Zisman (critical surface tension), Owens-Wendt (disperse and polar), van Oss and Good (acid-base theory), Schultz I+II (two-liquid method), Neumann's Equation of State (EOS), calculation of disperse and polar contributions of liquids based on measured surface and interfacial tensions as well as contact angles with error limits, calculation of wetting envelopes and other diagrams
Available variants:	<ul style="list-style-type: none"> • PCA 100M/x: portable handheld instrument • PCA 100R/x: for use with robot systems • /2 with multiple dosing system for two test liquids • /4 with multiple dosing system for four test liquids • RCC-Z 230: z-axis robot with max. 230 mm traverse • RCC-XY 400, 800, 1200, 1600: x/y-axis robot with max. 1600 mm traverse • MT FPD 400, 600: manual x-y sample tables with max. 600 mm traverse • other variants on request 	
Dimensions (L x W x H):	• 206 x 150 x 205 mm	• RCC footprint: subject to version
Weight:	<ul style="list-style-type: none"> • PCA 100M/2 5.2 kg • PCA 100R /2 5.2 kg • PCA 100M/4 5.6 kg • PCA 100R/4 5.6 kg • combined PCA 100R / RCC-XY1600 / RCC-Z230 1200 kg • combined PCA 100R / FPD 800 / RCC-Z230 800 kg 	
Power supply:	• 100...240Vac; 50...60Hz; 55 W	• 100...240 VAC; 50...60 Hz; 55 W (internal supply from switch cabinet with integrated PC and control system for the RCC components), RCC system 100–240 VAC, 50–60 Hz, approx. 800–1200 W depending on equipment

	DCAT 21 / DCAT 11
Measuring range for contact angles:	• 0...180 ° • resolution: ± 0.01 °
Measuring range for surface and interfacial tensions:	• DCAT 21: 1 ... 1000 mN/m; ± 0.001 mN/m • DCAT 11: 1 ...1 000 mN/m; ± 0.01 mN/m
Measuring range for densities:	• 0.50...2.50 g/cm ³ • resolution: ± 0.002 g/cm ³
Weighing range:	• 10 µg...210 g
Measuring value range	• max. 30 weighing values per second • for adsorption measurement: max. 50 weighed values per second
Traverse speed of sample table:	• DCAT 21: 0.7 µm/s ... 500 mm/min • DCAT 11: 2 µm/s ... 60 mm/min in measuring mode; 400 mm/min rapid traverse for init mode
Programmable traverse for sample table:	• DCAT 21: 105 mm • DCAT 11: 74 mm
Traverse resolution:	• DCAT 21: 0.1 µm • DCAT 11: 1 µm
Receiver for sample receptacles	• optionally 50 mm, 70 mm, or 100 mm diameter (TV 50...TV 100)
Sample sizes:	• max. weight: approx. 200 g • max. diameter / length: approx. 80 mm / DCAT 21 / 11: 110 mm / 90 mm • min. fiber diameter approx. 10 µm (approx. 3 µm with special receiver),
Balance lock:	• DCAT 21: electronic, software-controlled (auto balance locking) • DCAT 11: manual
Online display for status, weight, and temperature:	• integrated
Self-check and system diagnostics:	• integrated
Automatic stirrer for CMC measurements:	• magnetic stirrer integrated in TV 50 / 70 / 100; (optional non-magnetic version TV 70-NM with a removable micro-electronic stirrer system)
Software:	<ul style="list-style-type: none"> • SCAT 31: software module for surface and interfacial tensions, ring test, automatic ring correction • SCAT 32: software module for contact angles and surface energies on compact solids and powders, wetted lengths • SCAT 33: software module for CMCs with manipulation of LDU and Dosimat DO 765, forward and reverse CMCs, redosing of excess surfactant solution • SCAT 34: software module for liquid densities with optional density determination set DIS 11 • SCAT 35: software module for sedimentation / penetration with optional measuring bodies
Temperature range:	• -10 ... 130 °C with optional refrigerated and heating circulator • integrated temperature measurement and digital display
Temperature measurement and measuring range:	• 2 x Pt 100 inputs for -60–+450 °C (Pt 100 as option) • 0.01 K resolution, precision 1/3, DIN IEC 751 (±0.03%), Class B
Dimensions (L x W x H):	• DCAT 21: 305 x 230 x 4900 mm • DCAT 11: 305 x 230 x 4900 mm
Weight:	• DCAT 21: 25 kg • DCAT 11: 23 kg
Power supply:	100...240Vac; 50...60Hz; 55 W

	SVT 20
Measuring range for contact angles:	• 1·10 ⁻⁶ ... 2·10 ³ mN/m
Speed range:	• 0 ... 20 000 rpm, speed resolution ±0.001rpm, speed stability in long-term tests ±0.5 rpm, speed increments max. ±2000 rpm/s, oscillating frequency 0.005 ... 50 Hz at min. 3000 rpm
Traversing range of height-adjustable and tilting table:	• 220 x 70 mm, positioning accuracy 0.01 mm, • tilting range -12 ... +12 °, accuracy ±0.0002 °
Optics:	• 6-fold zoom lens (0.7 - 4.5 magnification) with integrated continuous fine focus (± 6 mm) • CCD camera with a resolution of max. 768 x 576 pixels, FOV 1.9 x 1.4 ... 12.1 x 9.1 mm, image distortion < 0.05%
Video system:	• high-performance image processing system with 132 MB/s data transfer rate (compatible with Euronorm CCR and US standard RS-170) • variable digitizing rate 50 (optionally 60) images per second
Measuring techniques:	Spinning drop method, oscillating spinning drop method
Capillary diameters:	• inner capillary diameter 8.0 mm (optional 2.45 mm) of borosilicate glass • special accessory: QGC / QGW quartz glass capillaries and quartz glass windows, SLV installation and capillary set for small quantities of liquid UV irradiation attachment for measuring cell (UVC)
Software:	<ul style="list-style-type: none"> • SCA 20/SVT: video measurement of drop contours, manipulation of the measuring objective's axis, the tilting table, and the capillary drive, control of stroboscopic and steady illumination, activation of the video system synchronised with the stroboscopic illumination for observing drops in various angular positions • SCA 25/SVT: calculation of surface and interfacial tensions based on spinning drop contours, predefined speed increments and sinusoidal speed variations for relaxation measurements, glass capillaries for automatically correcting distortions in drop contours
Temperature range:	• -10 ... 130 °C with optional refrigerated and heating circulator
Temperature measurement and measuring range:	integrated temperature measurement and digital display 2 x Pt 100 inputs for -60...+450 °C (1 x Pt 100 installed), 0.1 K resolution, precision 1/3, DIN IEC 751 (±0.03%), Class B
Dimensions (L x W x H):	390 x 390 x 400 mm
Weight:	25 kg
Power supply:	100 ... 240 VAC; 50 ... 60 Hz; 600 W

dataphysics

DataPhysics Instruments GmbH • Raiffeisenstraße 34 • D-70794 Filderstadt • Germany
phone ++49 (0)711 770556-0 • fax ++49 (0)711 770556-99
e-mail info@dataphysics.de • internet <http://www.dataphysics.de>



Visit our web site at www.dataphysics.de

Your sales partner:

Representante no Brasil
Labcontrol Ltda
Fone 11-5183-2092/5181-1173
E-mail: vendas@labcontrol.com.br